

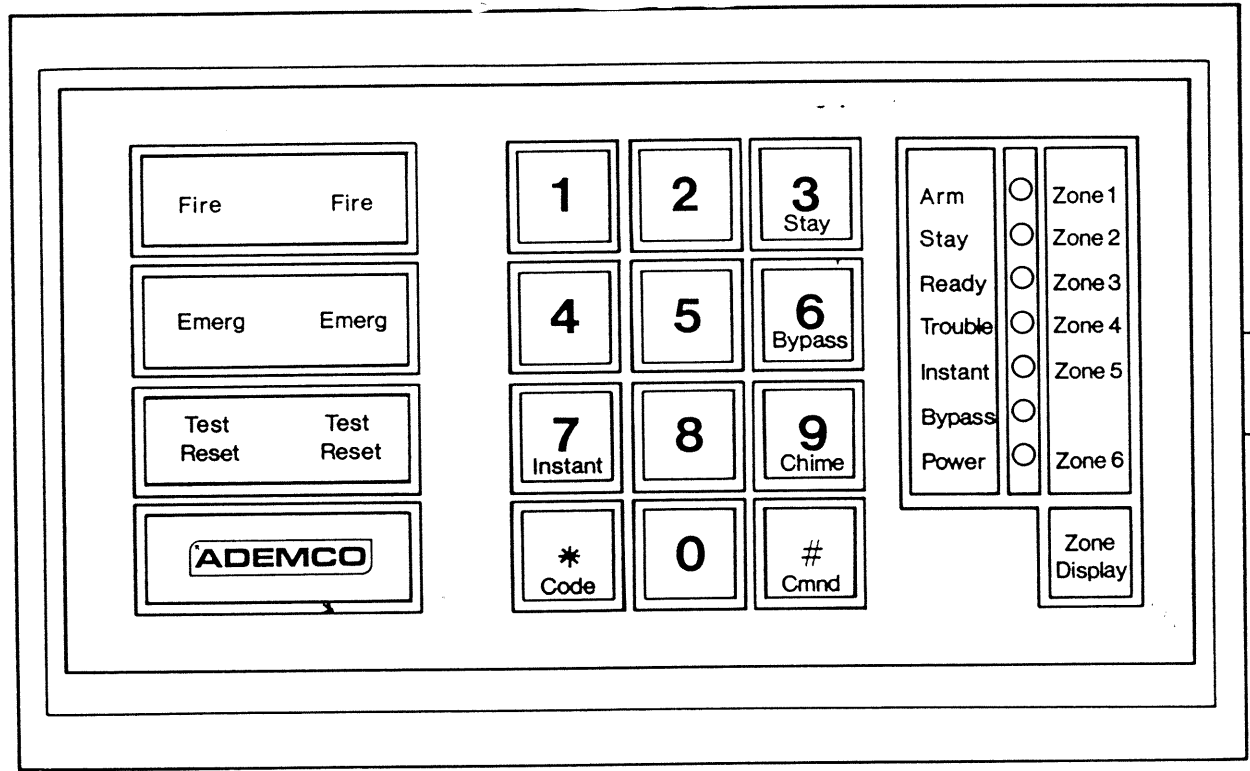

# Security System

4150  
Version 3



## USER'S MANUAL

# INTRODUCTION

---

Congratulations on your ownership of the system. You've made a wise decision in choosing it, for it offers the best security protection available to today's homeowner.

Basically, the system offers you three forms of protection: burglary, fire and emergency. To realize your system's full potential, it is important that you and everyone who will use the system feel comfortable operating it.

This manual is a step-by-step guide that will fully acquaint you with the system's features and benefits. It defines the components and their functions, describes their operation, and acquaints you with normal and emergency procedures.

The following glossary of terms used throughout the manual will avoid any confusion.

# GLOSSARY

---

## **ARM/DISARM:**

"Armed" simply means that the burglary portion of your system is turned ON, and is in a state of readiness. "Disarmed" means that the burglary system is turned OFF, and must be rearmed to become operational. However, even in the "disarmed" state, "emergency" and "fire" portions of your system will still be operational.

## **KEYPAD:**

This is your remote unit, containing numbered pushbuttons similar to those on telephones or calculators. These keys control the arming or disarming of the system, and perform other functions which will be described.

## **ZONE:**

A specific area of burglary protection.

## **BYPASS:**

To disarm a specific area of burglary protection while leaving other areas operational. Also, to disable a faulted remote emergency switch.

## **DELAY ZONE:**

An area of protection containing doors most frequently used to enter or exit (typically, a front door, back door, or door from the garage into the house). The delay zone allows for sufficient time for authorized entry or exit without activating the alarm. Consult your installer for the entry and exit delay times that have been set for your system during installation and record them on page 6.

# TABLE OF CONTENTS

System's Major Components .....	2
Functions of Remote Keypad .....	3-4
Audible Signals from Internal Speaker (s) .....	5
Alarm Signals from Exterior Sounder .....	5
Burglary Protection .....	6-8
Fire Protection .....	9
National Fire Protection Association	
Recommendations on Smoke Detectors .....	10
Emergency Evacuation .....	11
Your Own Evacuation Plan .....	12
Emergency Action .....	13-14
Chime Annunciation .....	14
Power Up Arming .....	14
Testing/ Servicing Procedures .....	15-17
Questions and Answers About Your Security System .....	18
Emergency Phone Numbers .....	21
The Limitations of Your Alarm System .....	22

## LIMITED WARRANTY

Seller warrants its products to be in conformance with its own plans and specifications and to be free from defects in materials and workmanship under normal use and service for 18 months from the date stamp control on the product or for products not having an Ademco date stamp, for 12 months from date of original purchase unless the installation instructions or catalog sets forth a shorter period, in which case the shorter period shall apply. Seller's obligation shall be limited to repairing or replacing, at its option, free of charge for materials or labor, any part which is proved not in compliance with Seller's specifications or proves defective in materials or workmanship under normal use and service. Seller shall have no obligation under this Limited Warranty if the product is altered or improperly repaired or serviced by anyone other than Ademco factory service. For warranty service, return product transportation prepaid, to Ademco Factory Service, 165 Eileen Way, Syosset, New York 11791.

THERE ARE NO WARRANTIES, EXPRESS OR IMPLIED, OF MERCHANTABILITY, OR FITNESS FOR A PARTICULAR PURPOSE OR OTHERWISE, WHICH EXTEND BEYOND THE DESCRIPTION ON THE FACE HEREOF. IN NO CASE SHALL SELLER BE LIABLE TO ANYONE FOR ANY CONSEQUENTIAL OR INCIDENTAL DAMAGES FOR BREACH OF THIS OR ANY OTHER WARRANTY, EXPRESS OR IMPLIED OR UPON ANY OTHER BASIS OF LIABILITY WHATSOEVER, EVEN IF THE LOSS OR DAMAGE IS CAUSED BY THE SELLER'S OWN NEGLIGENCE OR FAULT.

Seller does not represent that its product may not be compromised or circumvented; that the product will prevent any personal injury or property loss by burglary, robbery, fire or otherwise; or that the product will in all cases provide adequate warning or protection. Buyer understands that a properly installed and maintained alarm may only reduce the risk of a burglary, robbery or fire without warning, but it is not insurance or a guarantee that such will not occur or that there will be no personal injury or property loss as a result. CONSEQUENTLY, SELLER SHALL HAVE NO LIABILITY FOR ANY PERSONAL INJURY, PROPERTY DAMAGE OR OTHER LOSS BASED ON A CLAIM THE PRODUCT FAILED TO GIVE WARNING. However, if Seller is held liable, whether directly or indirectly, for any loss or damage arising under this Limited Warranty or otherwise, regardless of cause or origin, Seller's maximum liability shall not in any case exceed the purchase price of the product, which shall be fixed as liquidated damages and not as a penalty, and shall be the complete and exclusive remedy against Seller.

This warranty replaces all previous warranties and is the only warranty made by Ademco on this product. No increase or alteration, written or verbal, of the obligation of this Limited Warranty is authorized.

"Ademco" is a registered trademark of Alarm Device Manufacturing Company, Division of Pittway Corp.

# SYSTEM'S MAJOR COMPONENTS

Your system consists of the Control/Communicator and one (optionally up to four) Remote Keypad.

## THE CONTROL/COMMUNICATOR

The Control/Communicator is the brains of your system. Located out of sight, it receives signals, analyzes them, initiates alarms and transmits alarm messages to your police department or to a central alarm monitoring service.

**NOTE:** The telephone communication portion of your system is not listed by Underwriters' Laboratories (UL).

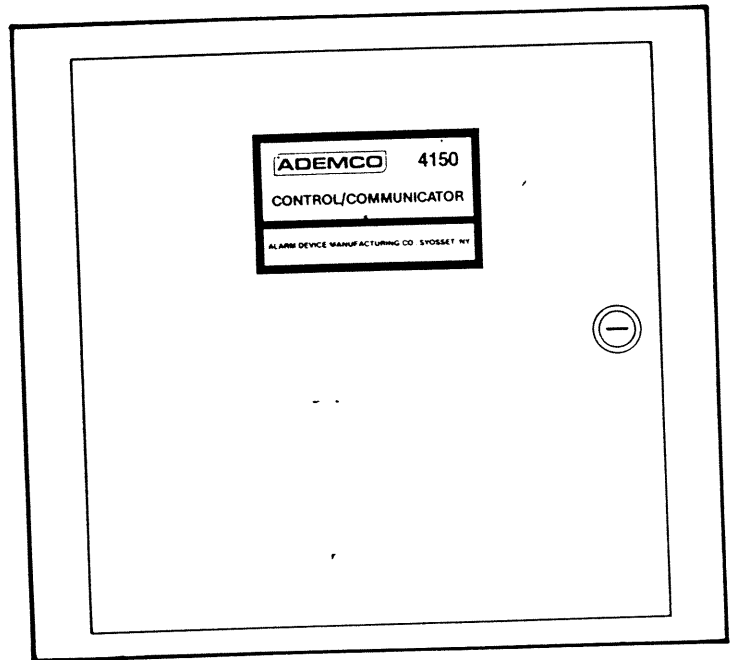

## THE REMOTE KEYPAD

The Remote Keypad is centrally located to suit your convenience. Its individual indicator lights display messages that inform you of the status of your system. The keypad enables you to arm or disarm the burglary portion of your system, and is also the source of warning sounds.

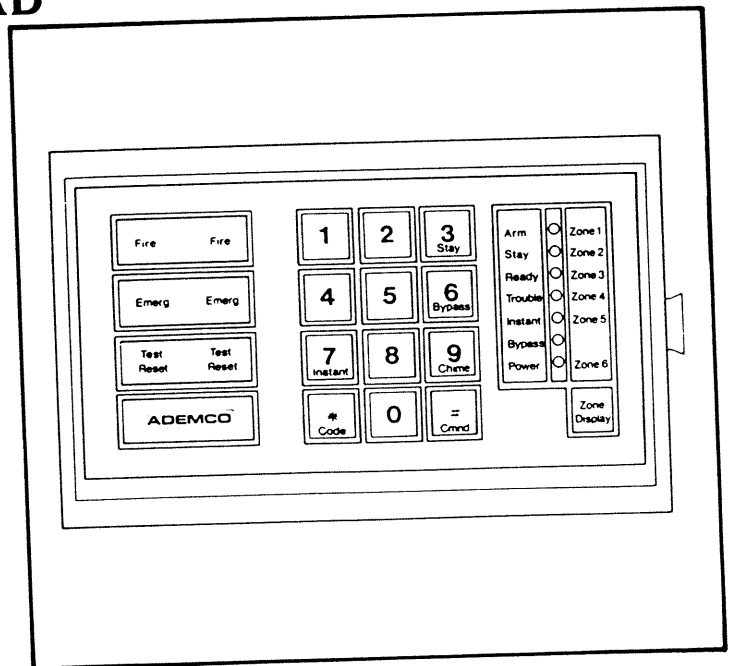

# FUNCTIONS OF REMOTE KEYPAD

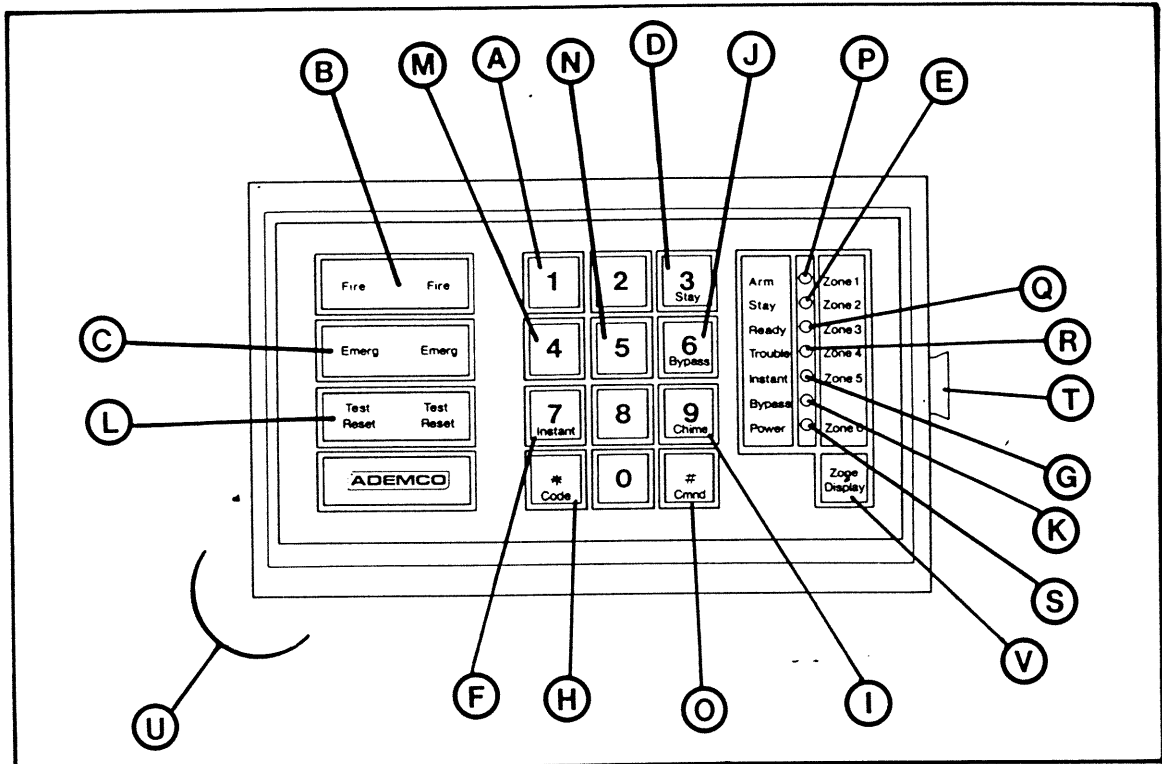

- A. KEYS 0-9** are used to enter your individual four digit Security Code to arm and disarm the system, to silence alarms and to change temporary security codes.
- B. FIRE/FIRE KEYS.** Pressing both keys at the same time initiates a FIRE alarm (if programmed) (page 9).
- C. EMERG/EMERG KEYS.** Pressing both keys at the same time will trigger either a silent alarm (if connected to a central alarm monitoring service or police agency), or an audible alarm (if programmed) (page 13).
- D. STAY KEY.** Bypasses, "turns off," the interior zone(s) of burglary protection leaving one free to move about the interior without tripping the alarm. The Yellow STAY Indicator lights to confirm this mode. [CMND] + [STAY] (page 7).
- E. STAY INDICATOR LIGHT (Yellow).** Lights to indicate STAY mode (see D).  
As a second function, when the ZONE DISPLAY Key is pressed and held for a few seconds, this indicator provides the status of Zone 2. When the ZONE DISPLAY Key is released, this light reverts to its normal STAY mode indicator function (page 7).
- F. INSTANT KEY.** This key eliminates the entry delay period causing an instant intrusion alarm for maximum protection when occupants are in to stay. The Yellow INSTANT indicator will light as a reminder that the Entry/Exit Zone is now in an Instant mode. Security Code - [CMND] + [INSTANT] (page 7).
- G. INSTANT INDICATOR LIGHT (Yellow).** Lights to indicate INSTANT mode (see F).  
As a second function, when the ZONE DISPLAY Key is pressed and held for a few seconds this indicator provides the status of ZONE 5. When the ZONE DISPLAY Key is released, this light reverts to its normal INSTANT mode indicator function (page 7).
- H. CODE KEY.** Use this key to enter temporary four digit Security Codes. Useful when given to those who have temporary access, such as babysitters, or employees. [CODE] - Master Code + Code Designator - Temporary Code (page 6).  
It is also used to enter a Duress Code (page 13).
- I. CHIME KEY.** This key turns on the CHIME mode. When the system is disarmed, a short tone from the keypad(s) will signal any opening of a sensor in an Entry/Exit Zone. Useful for monitoring the activity of a back door during the day. [CMND] + [CHIME] (page 14).
- J. BYPASS KEY.** Used to turn off part of the protection system. Allows the system to be armed should a fault condition exist in part of the burglary system. [CMND] + [BYPASS] +N where N is the number of the zone (page 17).
- K. BYPASS INDICATOR LIGHT (Yellow).** Lights to indicate that a zone has been bypassed (see J).
- L. TEST/RESET KEYS.** Depressing either or both of these keys resets and tests the fire alarm system and silences the beep that accompanies a steadily lit trouble light. [CMND] + [TEST/RESET] (page 9, 16).
- M. "4" KEY.** Puts the system into the Burglary System Test Mode when used with the CMND key. [CMND] + [4] (page 15).
- N. "5" KEY.** Sends a test report to your central alarm monitoring service when used with the CMND key. [CMND] + [5] (page 15).
- O. CMND KEY.** Depression of this key is required prior to pressing any of the function keys described in sections D, F, I, J, L, M and N above.
- P. ARM (Red).** Flashes during the allowable exit time after the burglary system is turned on. Lights steadily at the end of this time to indicate complete turn-on of protection. Also flashes to indicate that an audible alarm has taken place.

As a second function, when the ZONE DISPLAY Key is pressed and held for a few seconds this indicator provides the status of ZONE 1 (Fire). When the ZONE DISPLAY Key is released, this light reverts to its normal ARM mode indicator function (page 17).

- Q. READY INDICATOR LIGHT (Green).** Lights when all burglary zones are intact and ready for arming. Remember that the STAY function turns off the interior zone and the BYPASS function turns off any other burglary zone. Flashes along with ARM Indicator Light to indicate that an audible alarm has taken place (page 7).

The READY Indicator Light serves a second function. When the ZONE DISPLAY key is pressed and held for several seconds, this indicator provides the status of ZONE 3.

When the ZONE DISPLAY key is released, this light reverts to its normal system READY indicator function (page 17).

- R. TROUBLE INDICATOR LIGHT (Red).** Lights steadily if there is a problem in the fire system. Also lights steadily if there is a problem with emergency switches (page 17).

As a second function, when the ZONE DISPLAY key is pressed and held for a few seconds, this indicator provides the status of Zone 4. When the ZONE DISPLAY key is released, this light reverts to its normal TROUBLE indicator function (page 17).

- S. POWER INDICATOR LIGHT (Green).** Lights steadily if AC power is present to operate the system. Flashes when AC power is lost and the system is operating from its back-up battery.

As a second function, when the ZONE DISPLAY key is pressed and held for a few seconds, this indicator provides the status of Zone 6. When the ZONE DISPLAY key is released, this light reverts to its normal POWER indicator function (page 17).

- T. PULL-OUT DRAWER.** Contains cards on which useful information for the user is printed and can be written.

- U. INTERIOR SPEAKER.** Source of audible internal warning and confirmation sounds.

- V. ZONE DISPLAY KEY.** Holding this key depressed causes the zone status display to be activated for Zones 1 through 6 (See E, G, P, Q, R, S).

**IMPORTANT**  
**AFTER A SUSTAINED AC POWER OUTAGE, SYSTEM (BATTERY)**  
**MAY REQUIRE RECOVERY PERIOD OF UP TO 24 HOURS BEFORE IT**  
**IS AGAIN CAPABLE OF SOUNDING AND COMMUNICATING**  
**ALARMS.**

---

# AUDIBLE SIGNALS FROM INTERNAL SPEAKER(S)

## Invalid Code Entry:

5-6 consecutive low-level tones indicate that the wrong 4-digit code has been entered.

## Armed Indication:

One low-level tone sounds when the system is successfully armed.

## Entry/Exit Zone Chime Indication:

One low-level tone sounds upon activation of a sensor in an Entry/Exit zone when the Chime mode is used.

## TROUBLE Indication:

Once every 15 seconds low-level tone while the TROUBLE Indicator is on steady. Conditions for which the trouble indicator lights are described on page 17.

**NOTE:** Depression of CMND + TEST/RESET silences the trouble tone and causes the TROUBLE indicator to flash. The trouble tone turns on 24 hours later if the trouble condition is not corrected.

## Entry Warning:

Steady low-level tone that is activated during the entry delay period.

## Key Depression:

A brief tone is sounded for each key pressed that is not in the dual key FIRE and EMERG sections of the keypad.

## Power Up Arming Indication:

Steady low-level tone that is activated when the system is powered up and which lasts for one minute. Upon expiration of the one minute period, the system arms itself (page 14).

---

# ALARM SIGNALS FROM EXTERIOR SOUNDER

## Fire Alarm:

Loud pulsing sound. Continues until silenced (see page 9) or it automatically shuts off (may be up to 15 minutes as programmed by the installer, **but** UL Listed fire alarm applications may **not** shut off automatically). **NOTE:** Fire alarm sounding takes priority over burglary/panic alarm sounding if both alarms occur at the same time.

## Burglary/Audible Panic Alarm:

Loud steady sound. Continues until system is disarmed (see page 8) or reset (see page 13) or it automatically shuts off (may be silent or up to 15 minutes as programmed by the installer, **but** UL Listed household burglary applications require at least 4 minutes of sounding).

# BURGLARY PROTECTION

## HOW TO ARM YOUR BURGLARY SYSTEM

Your system provides two levels of burglary protection; exterior and interior. The former guards doors, windows, etc., sounding an alarm if one is opened by an intruder. Interior protection offers backup defense, sensing when an unauthorized person is moving about inside.

## FOUR-DIGIT SECURITY CODES

At the time of installation, you chose a personal four-digit code, known only to you and yours and programmed by your installer. ARMING and DISARMING of your burglary alarm system is accomplished by entering this code at any Remote Keypad.

As an additional safety feature, two secondary codes may be utilized at any time. Persons who, in your absence, must arm the system upon departure, can be provided with different temporary codes that allow arming and disarming and all other system functions **except** assigning or changing of the secondary codes themselves. Your master code remains in effect even when a secondary code is present.

The secondary codes can be entered, or changed, at any Remote Keypad, as follows: Press the CODE key. Enter the master code, depress the key (1 or 2) \* designating the secondary code, then key in the desired temporary secondary code. To eliminate the secondary code, repeat this sequence, refraining from any code entry for 10 seconds after keying the secondary code designator (1 or 2)

\*The Code Designator is either 1, 2 or 3.  
1=First Temporary Code  
2=Second Temporary Code  
3=Duress Code (page 13)

**NOTE:** Entry of an invalid four-digit code will result in 5-6 rapid consecutive tones being produced at your Remote Keypad.

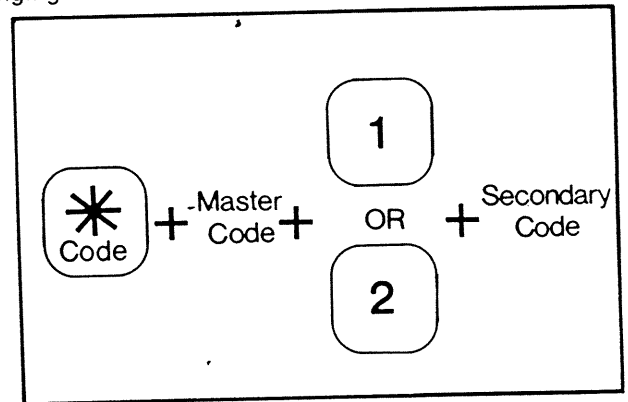

## DELAY ZONE ENTRY AND EXIT TIMES

These are set by your installer during installation and determine the number of seconds available for exit and entry through the delay zone, when arming and disarming the burglary protection, to avoid setting off an alarm.

Record the delay times for your system here:

**EXIT DELAY:** \_\_\_\_\_ seconds (may be from 8 to 120 seconds but no more than 60 seconds for a UL Listed household burglary application).

**ENTRY DELAY:** \_\_\_\_\_ seconds (may be from 8 to 120 seconds but no more than 45 seconds for a UL Listed household burglary application).



## WHILE INSIDE

1. Check the Green READY Indicator Light on your Remote Keypad. It should be on to indicate that your system is ready to be armed. Depress your CMND key and depress the STAY key at your keypad. The Yellow STAY Indicator light will illuminate. Enter your security code. The Red ARM Indicator light will flash. You will hear one tone from your Remote Keypad. The Red ARM Indicator Light will be lit steady after your exit delay has ended. You have now ARMED successfully with the ability to walk freely through the interior of your home.
2. INSTANT (Entry Delay Off) Arming. If you wish the act of opening one of your main access doors to instantly trigger an alarm (as might be the case when the family has retired), do the following: Depress the CMND and then the STAY keys at the keypad. Enter your security code. Depress the CMND key and then the INSTANT key. The Red ARM and the Yellow INSTANT and STAY Indicator Lights will illuminate and you will hear one tone from your Remote Keypad.
3. The STAY and INSTANT modes are de-activated the next time the system is disarmed.

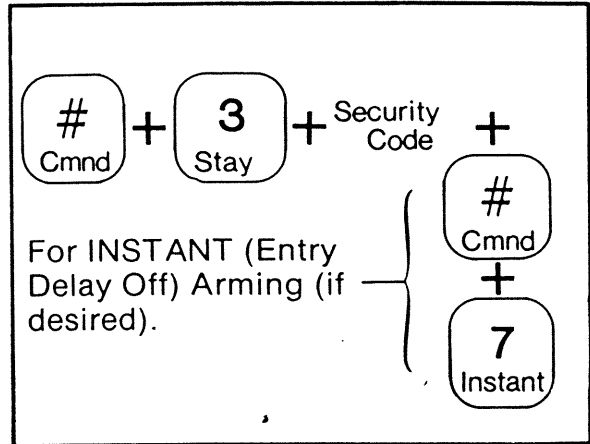

**NOTE:** If the Green READY Indicator Light on your Keypad is not on then one or more zones in your burglary protection system are disturbed. Depress and hold the ZONE DISPLAY Key. The zone identification indicators will be lit for any disturbed zones. The problem must be corrected before arming can take place. See "Identifying and Remediating a Zone Malfunction" on page 17.

If it is desired to leave a door or window open intentionally, such as in the summertime, use the procedure in Step 4 of Remediating a Zone Malfunction on page 17.

## WHEN LEAVING WITH NO ONE REMAINING

1. Check the Green READY Indicator Light on your Remote Keypad. It should be on, indicating that the system is ready for arming. If not, see page 17.
2. Enter your security code. The Red ARM Indicator Light will flash and you will hear one tone from your Remote Keypad signifying that the system is ARMED. The exit delay period set during installation (see page 6) determines the time you have to leave through your chosen exit door before passage will cause an alarm to sound. The Red ARM Indicator will be lit steady at the end of a brief delay.

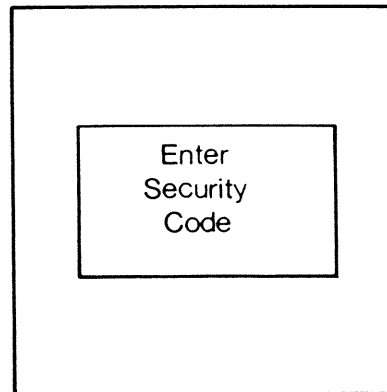

## HOW TO DISARM YOUR BURGLARY SYSTEM UPON ENTERING

1. Enter via a door in your Delay Zone. You will hear a steady, low-level tone from your Remote Keypad.

The entry delay period set by your installer during installation (see page 6) determines the time you have to reach your Remote Keypad and DISARM the burglary portion of your system.

2. Enter your security code. The Red ARM Indicator Light will go out. You may open and close doors and windows and move freely, without setting off an alarm.

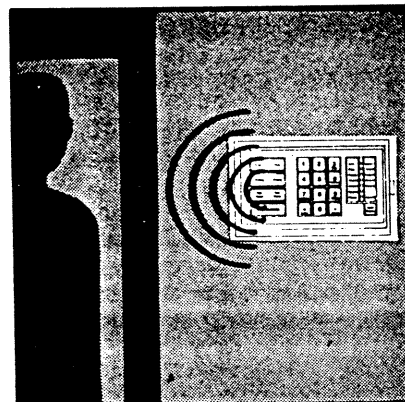

### IMPORTANT

**BEFORE** keying your security code, observe the ARM and READY Indicator Lights on your Remote Keypad. If they are flashing, an intrusion has occurred during your absence. Leave immediately and contact the police from the nearest safe location.

### WHILE INSIDE

1. Go directly to the nearest keypad. Enter your security code. The Red ARM and the Yellow STAY Indicator Lights will go out. You may now open and close doors and windows and move freely, without setting off an alarm.

**NOTE: While the system is DISARMED, the Green READY Indicator Light will go on and off as various sensors are activated by your normal activities.**

# FIRE PROTECTION (IF INSTALLED)

## OPERATION OF YOUR FIRE ALARM SYSTEM

Your fire alarm system is "ON" 24 hours a day, for continuous protection. In the event of an emergency, the strategically located smoke detectors will automatically send signals to your Control/Communicator triggering a loud, pulsed alarm sound at exterior speakers (unless bells are used).

Should you become aware of a fire emergency before your detectors sense the problem, go to your nearest keypad. Manually initiate an alarm by depressing both FIRE Keys simultaneously (if programmed for use).

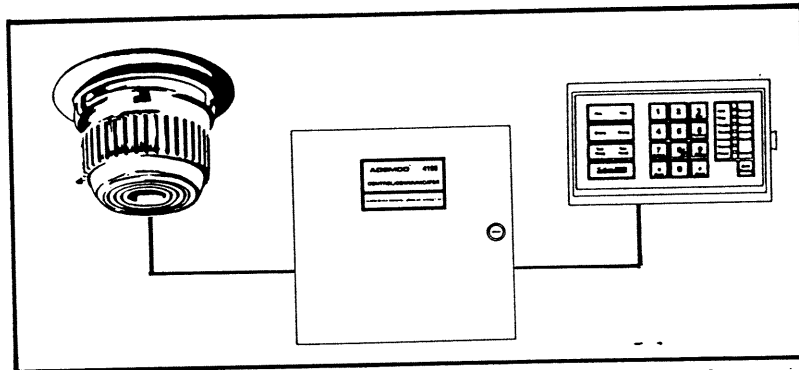

In any event, your first action should be to make sure that all occupants are safely evacuated. That done, if no flames or dense smoke are apparent, investigate the cause of the alarm.

1. Silence the alarm by entering your security code.
2. If the TROUBLE light is on (either steadily or flashing), then your fire system is still faulted and must be manually reset. Press the CMND and TEST/RESET keys to reset the fire system. The trouble light will then flash for about 14 seconds. If the flashing trouble indication persists for longer than 14 seconds, then a detector has failed to reset. There still may be smoke in a detector. Clear it by fanning the affected detector for about 30 seconds. Attempt to reset the fire system again by pressing the CMND and TEST/RESET keys.
3. If the trouble light has turned off, follow the procedure on page 16 for testing the battery and circuits of your fire alarm system.
4. When the problem has been corrected, the TROUBLE Light will go out and the trouble tone will cease sounding.

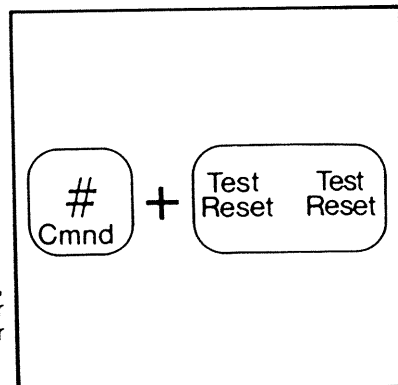
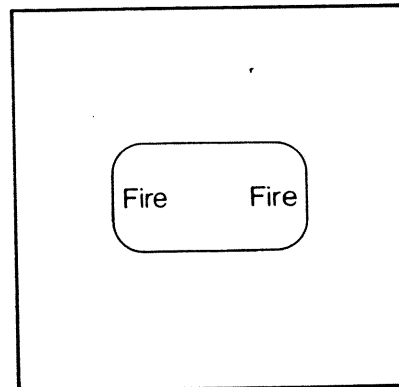

# NATIONAL FIRE PROTECTION ASSN. RECOMMENDATIONS ON SMOKE DETECTORS

With regard to the number and placement of smoke and heat detectors, we subscribe to the recommendations contained in the National Fire Protection Association's Standard #74, noted below:

Early warning fire detection is best achieved by the installation of fire detection equipment in all rooms and areas of the household as follows:  
A smoke detector installed in each separate sleeping area, (the vicinity of, but

outside of the bedrooms), and heat or smoke detectors in living rooms, dining rooms, bedrooms, kitchens, hallways, attics, furnace rooms, closets, utility and storage rooms, basements and attached garages.

**NOTE:** "Approval of the panel's burglar alarm functions does not fall within the (California) State Fire Marshal's area of jurisdiction."

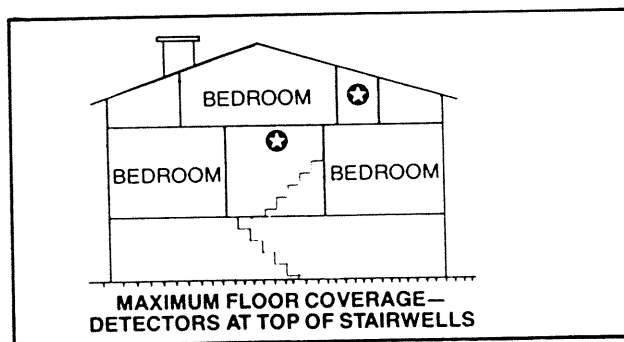
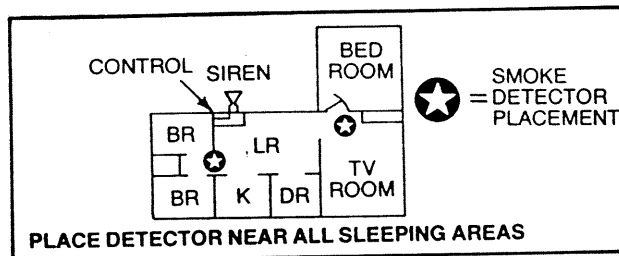
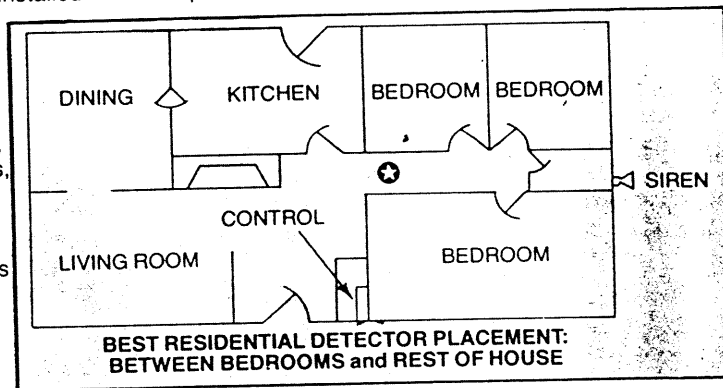

# EMERGENCY EVACUATION

Every family should take steps to establish and regularly practice a plan of escape in the event of a fire. The following steps are recommended by the National Fire Protection Association and can be used as a guide in developing your own emergency plan.

1. Plan on your detector or your interior and/or exterior sounders waking the family.
2. Determine two means of escape from each room in your home, particularly the bedrooms, since most home fires occur at night when everyone is asleep. One path of escape should lead to the door that permits normal exit from the house. The other may be a window which opens easily to permit escape should your primary path be unpassable. It may be necessary to station an escape ladder at such windows if there is an unusually long drop to ground below.
3. Sketch a floor plan of your home. Show windows, doors, stairs and rooftops that can be used to escape in the event of fire. Indicate escape routes for each room. Remember to keep these routes free from obstruction and post copies of the escape route sketch in every room.
4. Make sure that all bedroom doors are shut while the family is asleep. This will prevent deadly smoke from entering while you escape.
5. Try the door. If it is hot, check your alternate escape route. If the door is cool, use your shoulder to open it cautiously. Be prepared to slam the door if smoke or heat rushes in.
6. Crawl in the smoke and hold your breath.
7. Escape quickly; don't panic.
8. Establish a common meeting place outdoors, away from your house where everyone can meet and then take steps to contact the authorities and account for those missing. Choose someone to assure that nobody returns to the house — many die going back.

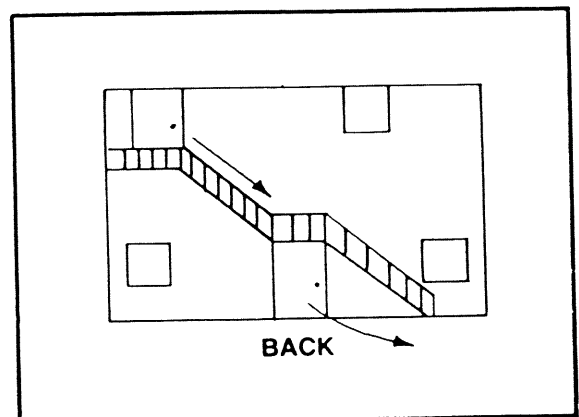
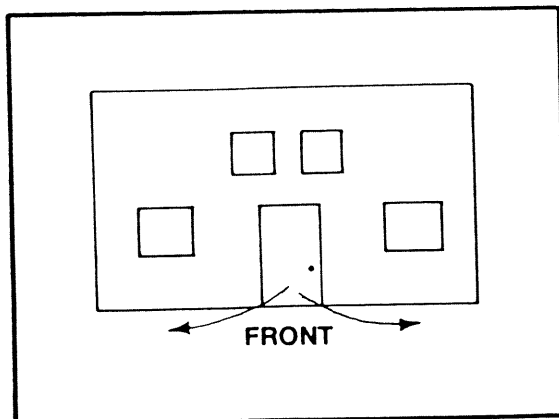
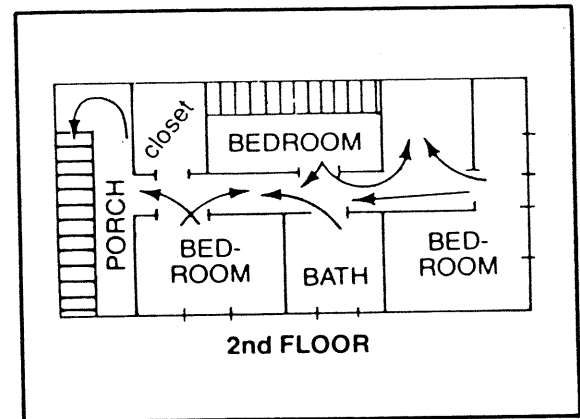
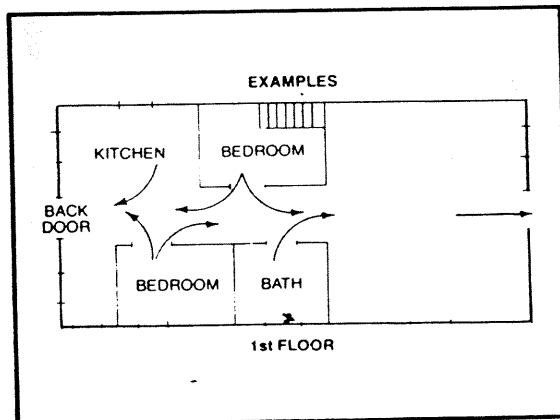

# DRAW YOUR OWN EVACUATION PLAN

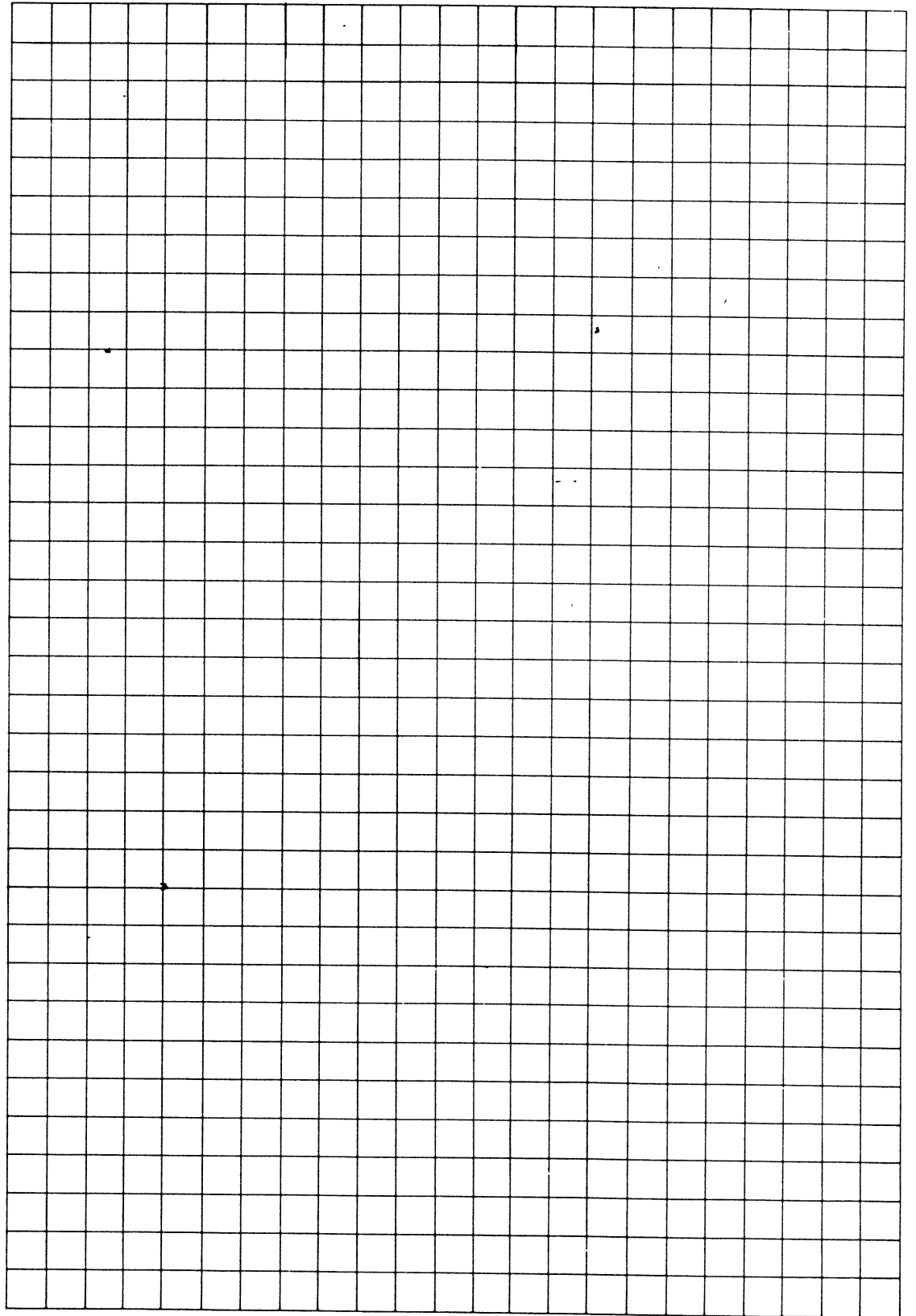

# EMERGENCY ACTION

**NOTE:** The emergency portion of your system is always "ON", whether or not the burglary system is armed. This line of defense allows you to sound a loud panic alarm (or to send a silent emergency signal to appropriate agencies, if such provisions have been made).

## HOW TO SOUND AN AUDIBLE PANIC ALARM (IF AUDIBLE PANIC IS INSTALLED)

1. To trigger the alarm you have two options:
  - A. Simultaneously depress both EMERG Keys on any Keypad.
  - B. Press any remote emergency switch.
2. In either case a loud continuous sound will be produced at your exterior siren or bell.
3. To silence the alarm sounder, enter your security code at the nearest keypad. If the TROUBLE indicator lights, a remote emergency switch may be in the faulted position. Press and hold the ZONE DISPLAY KEY for a few seconds to view the zone containing the faulted switch. If unable to remedy see "Identifying and Remediating a Zone Malfunction" on page 17.

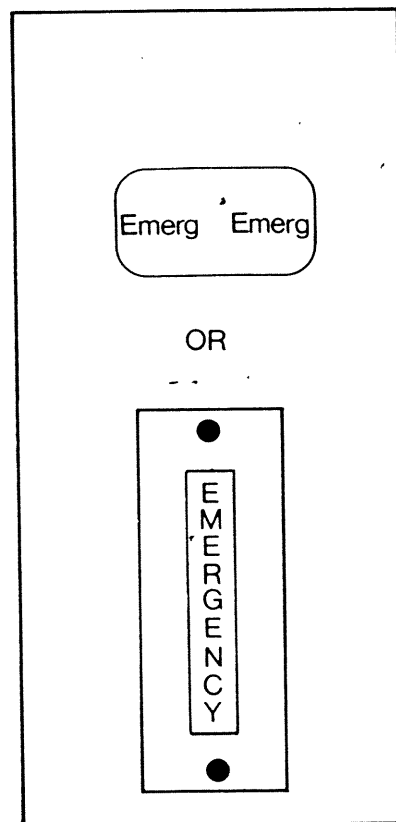

## HOW TO SEND A SILENT EMERGENCY ALARM

**NOTE:** Usage of this feature is relevant only if optional communication devices are connected to a local police department or alarm monitoring service (the telephone communication portion of your system is not Listed by UL).

1. You have three options:
  - A. Simultaneously press both EMERG keys on any keypad.\*
  - B. Press any silent emergency switch.\*
  - C. Enter your Duress code to disarm the system.

The latter is a separate secondary security code. If the code is keyed, normal system disarming takes place. This code could be used if you were hostage to an intruder and were directed to disarm your system. Installation of the duress code is accomplished by using the procedure on page 6 for entry of temporary secondary security codes with the one exception that the code designator keyed after the security code would be "3".

**\*NOTE:** If silent panic is installed.

2. Your system's Silent Emergency communication equipment will activate immediately, but no siren or bell will sound.

## CHIME ANNUNCIATION

Your system is capable of alerting you to the opening of a door during the DISARMED state. To use this feature:

1. Depress the CMND key and then press the CHIME key.
2. Should a door or window in the ENTRY/EXIT zone open, a single tone will sound from any Remote Keypad.
3. To turn off this feature, again depress the CMND key and press the CHIME Key.

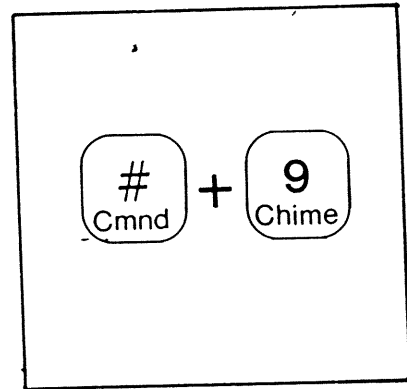

## POWER UP ARMING

This mode, if programmed at installation time, provides maximum security when you are away for an extended period of time.

After a complete power loss (including battery back-up) followed by restoration of power, the system enters a Power Up Arming Mode. In this mode, the keypad beeps steadily for a one minute period. Subsequently, the system bypasses any faulted zones and arms itself. Any key depression during the one minute period will abort the Power Up Arming Mode and the system returns to a disarmed state.



# TESTING AND SERVICING PROCEDURES

## HOW TO TEST YOUR BURGLARY SYSTEM

**IMPORTANT:** It is recommended that your burglary system be tested at least once a week, as follows:

1. Make sure that the system is disarmed. Depress the CMND Key and press the "4" Key.
2. Open and close each protected door and window. Each action should produce a brief loud sound from your exterior alarm sounder.
3. Walk in front of your interior motion detector(s) (if used). Listen for the same loud sound each time the detector senses your movement.
4. To turn off the TEST MODE, depress any key.

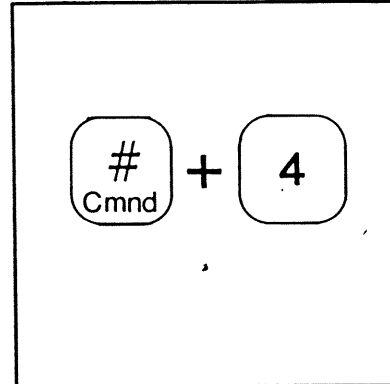

## HOW TO TEST YOUR COMMUNICATIONS

If your system is connected to a central alarm monitoring service:

1. Call the monitoring service and tell them you are going to test your system. Be prepared to properly identify yourself.
2. Press CMND + "5".
3. You may not be able to use your telephone for a few minutes.
4. When dial tone returns, call the monitoring service to verify receipt of your test signal.

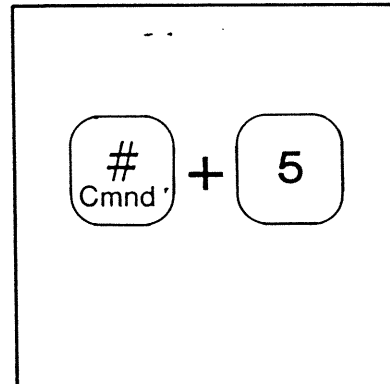

Contact your installing dealer for details. **Note:** The telephone communication portion of your system is not Listed by UL.

## HOW TO TEST YOUR FIRE ALARM SYSTEM

**IMPORTANT!** It is recommended that your fire alarm system be tested at least once per week.

1. Depress the CMND and the TEST/RESET keys. Your exterior alarm sounder will emit a loud sound for two seconds. The POWER indicator light will flash for two seconds and the TROUBLE indicator light will flash for fourteen seconds. If no sound is heard, the back-up battery is disconnected or improperly charged. Contact your installing dealer for assistance.

**NOTES: A.** After each alarm condition, the system should be tested in order to make certain that all circuits are operating.

- B. Depression of CMND and then the "1" keys has the same effect as depression of the CMND and then the TEST/RESET keys.

2. Test any smoke detector(s) installed with your system weekly, in accordance with the smoke detector manufacturer's instructions.

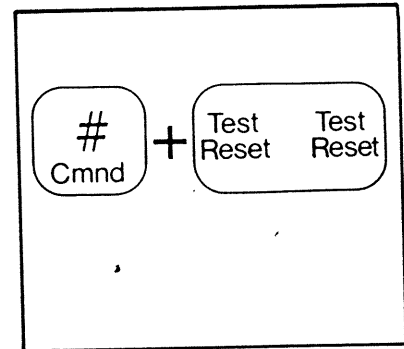

## TO THE USER

This equipment has been tested to FCC requirements and has been found acceptable for use. The FCC requires the following statement for your information:

This equipment generates and uses radio frequency energy and, if not installed and used properly, that is, in strict accordance with the manufacturer's instructions, may cause interference to radio and television reception. It has been type tested and found to comply with the limits for a Class B computing device in accordance with the specifications in Subpart J of Part 15 of FCC Rules, which are designed to provide reasonable protection against such interference in a residential installation. However, there is no guarantee that interference will not occur in a particular installation. If this equipment does cause interference to radio or television reception, which can be determined by turning the equipment off and on, the user is encouraged to try to correct the interference by one or more of the following measures:

- If using an indoor antenna, have a quality outdoor antenna installed.
- Reorient the receiving antenna until interference is reduced or eliminated.
- Move the receiver away from the control/communicator.
- Plug the control/communicator into a different outlet so that control/communicator and receiver are on different branch circuits.
- Move the antenna leads away from any wire runs for control/communicator (in particular wire runs to any Remote Keypad).
- If necessary, the user should consult the dealer or an experienced radio/television technician for additional suggestions. The user may find the following booklet prepared by the Federal Communications Commission helpful: "How to Identify and Resolve Radio-TV Interference Problems". This booklet is available from the U.S. Government Printing Office, Washington, DC 20402. Stock No. 004-0000-00345-4.

In the event of telephone operational problems, disconnect the control/communicator by removing the plug from the RJ31X jack. We recommend your certified installer demonstrate disconnecting the phones on installation of the system. Do not disconnect the phone connection inside the control/communicator. Doing so will result in the loss of your phone lines. If your regular phone works correctly after the control/communicator has been disconnected from the phone lines, the control/communicator has a problem and should be returned for repair. If upon disconnection of the control/communicator, there is still a problem on your line, notify the telephone company that they have a problem and request prompt repair service. The user may not under any circumstances (in or out of warranty) attempt any service or repairs on the system. It must be returned to the factory or an authorized service agency for all repairs.

**NOTE:** When the system is communicating with the central alarm monitoring service, the phone line is seized and the user's phones are disconnected. Under normal circumstances, the phone line seize should only be 1-2 minutes. However, line seize could last up to 15 minutes if trouble exists. If this occurs regularly, contact your installer.

## IDENTIFYING MALFUNCTION

If a memory of alarm indication (flashing ARM and READY indicators) is present, clear it by entering your security code. Refer to the table below to identify the source of problem within your system.

READY INDICATOR	TROUBLE INDICATOR	ZONE INDICATOR	SOURCE OF PROBLEM
On Steady	Off	(see note 1)	Everything OK
On Steady	On (Steady or Flashing)	(see note 2)	Fire System
Off	On (Steady or Flashing)	On Steady (except Zone 1)	Emergency Switch
Off	Off	One or More On (see note 3)	Burglary System

**Note 1:** Off—Zone intact. No prior Alarm

On Flashing—Zone intact. There has been a prior alarm. This indication is cleared when system is next armed.

**Note 2:** Zone 1 Off—Smoke detector power has failed or there is a wire break in the Fire Zone.

Zone 1 On Steady—Smoke detectors, thermostats or pull stations are faulted.  
There has been a prior alarm.

**Note 3:** On steady—Zone currently faulted. No prior alarm.

On Flashing—Zone currently faulted. There has been a prior alarm.

## REMEDYING MALFUNCTION AND BYPASSING ZONES

1. If the problem is with the fire system, perform steps 2 and 3 of "Fire Alarm System Operation" on page 9.

2. If the problem is with the emergency system, check the condition of your remote emergency switches. Contact your service company for assistance if the problem is not corrected by returning the switch to its "normal" position.

3. If the problem is with the burglary system, check the condition of all sensors in the affected zone. Contact your service company for assistance if all sensors appear OK.

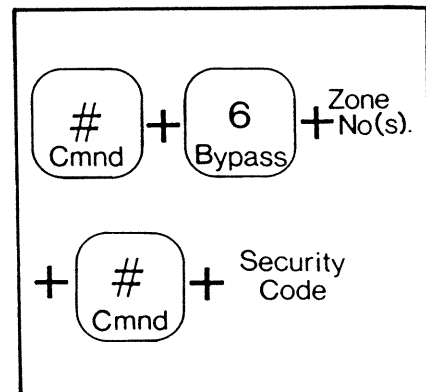

4. If you desire to arm the burglary system with partial protection (problem burglary zone excluded, or leave a window or door open), then press the CMND and BYPASS keys, followed by the zone number(s) to be bypassed. Related zone indicator light(s) will light steady, indicating the zone is bypassed. After all desired zones are bypassed, press CMND key to exit bypass mode. BYPASS indicator light will change from flashing to steady (it flashes while in bypass mode), indicating some zones are bypassed. Enter your security code and the ARM indicator should light. One brief tone will be heard as an audible confirmation of arming.

# QUESTIONS AND ANSWERS ABOUT YOUR SECURITY SYSTEM

- Q. I'm in. My system is armed. I accidentally set off the burglar alarm. What should I do?**
- A.** Go to your nearest keypad. Enter your security code. This will silence the interior and exterior alarm sounders.  
If your alarm is connected to a police department or alarm monitoring service, telephone them immediately to advise that the alarm was accidental.
- Q. I have an employee. I want that person to arm the system when they leave, but have no ongoing control over it. What should I do?**
- A.** Enter a temporary security code at any keypad and instruct your employee in its use. The temporary code can be changed when its usefulness is over.
- Q. Cooking smoke has inadvertently triggered my fire alarm. What should I do?**
- A.** If your system is connected to a fire department or alarm monitoring service, immediately advise them it's a false alarm. At the nearest keypad, enter your security code. Press the CMND and TEST/RESET keys. This will silence the alarm and reset the fire protection. Should the trouble light flash, check the smoke detectors in the affected area. Clear any residual smoke in the detector's chamber by fanning it for 30 seconds. Depress the CMND and TEST/RESET keys again. If the flashing continues, call your service company.
- Q. How does the system help me avoid false alarms?**
- A.** A built-in Fail/Safe feature prevents you from arming the system while any of its sensors are not intact. Unarmed, no false alarm can occur. In addition, the signalling of your central monitoring service can be delayed by 15 seconds (programmed at installation). This permits you to turn the system off after you have inadvertently caused an alarm, but before an alarm monitoring station or the police are notified (if your system is so connected). This option should be discussed with your installer.
- Q. I become aware of the presence of an intruder. What should I do?**
- A.** If the Silent Emergency feature is connected to a police department or alarm monitoring station, push your Silent Emergency button or simultaneously press both EMERG keys on your nearest keypad. If you don't have this optional connection, try to escape to the nearest safe location and call for help.
- Q. I return and my burglar alarm is sounding or my alarm memory display is present. What should I do?**
- A.** Do not enter. Go to the nearest phone and call the police.
- Q. What should I do if I hear my fire alarm?**
- A.** Following your pre-arranged Emergency Evacuation Plan, help all occupants safely escape, then contact the fire department from a safe location.
- Q. I'm alone, incur a personal emergency and need help.**
- A.** If your system is connected to a police department or alarm monitoring station, you may summon help by using your nearest keypad. Simultaneously press the two keys (EMERG/EMERG) your installer has configured for either silent or audible panic.
- Q. I'm in and want both intrusion protection and freedom of movement in the interior of my place.**
- A.** At the nearest keypad, press the CMND and then the STAY key, so that its related indicator Light is ON. Enter your security code so that the ARM Indicator is lit. (You will also hear one low-level tone). The perimeter is now protected.
- Q. I'm in and want an instantaneous alarm to be sounded if an intruder attempts to break in via my primary access door(s).**
- A.** At the nearest keypad, press CMND and then the STAY keys. Enter your security code. Press the CMND key, then the INSTANT key. The STAY, ARM and INSTANT Indicator Lights will go ON and you will hear one low-level tone. Your system is armed and the Entry Delay period has been cancelled.
- Q. The POWER light on my Remote Keypad flashes. What should I do?**
- A.** Though the POWER light flashes immediately upon the loss of AC power to the system, the system is still operating from its back-up battery.
1. If some lights are out, check circuit breakers and fuses and reset or replace as necessary.
  2. Check to see that your system's plug-in transformer has not been accidentally pulled out.
  3. If these steps do not restore power to the system, call your service representative.

# OWNER'S INSURANCE PREMIUM CREDIT REQUEST

This form should be completed and forwarded to your homeowner's insurance carrier for possible premium credit.

## A. GENERAL INFORMATION:

Insured's Name and Address: \_\_\_\_\_

Insurance Company: \_\_\_\_\_ Policy No.: \_\_\_\_\_

Ademco Control/Communicator Model No. 4150

Type of Alarm:  Burglary  Fire  Both

Installed by: \_\_\_\_\_ Name \_\_\_\_\_ Serviced by: \_\_\_\_\_ Name \_\_\_\_\_

Address \_\_\_\_\_ Address \_\_\_\_\_

## B. NOTIFIES (Insert B = Burglary, F = Fire)

Local Sounding Device: \_\_\_\_\_ Police Dept.: \_\_\_\_\_ Fire Dept.: \_\_\_\_\_

Central Station: \_\_\_\_\_ Name and Address: \_\_\_\_\_

(OVER)

**C. POWERED BY:** A.C. With Rechargeable Power Supply

**D. TESTING:**  Quarterly  Monthly  Weekly  Other \_\_\_\_\_

**E. SMOKE DETECTOR LOCATIONS**

Furnace Area \_\_\_\_\_, Kitchen \_\_\_\_\_, Bedrooms \_\_\_\_\_, Attic \_\_\_\_\_, Basement \_\_\_\_\_, Living Room \_\_\_\_\_,  
Dining Room \_\_\_\_\_, Hall \_\_\_\_\_

**F. BURGLARY DETECTING DEVICE LOCATIONS**

- Front Door  Basement Door  Rear Door  All Exterior Doors  1st Floor Windows
- All Windows  All Accessible Openings, Including Skylights, Air Conditioners and Vents
- Interior Locations

**G. ADDITIONAL PERTINENT INFORMATION:**

\_\_\_\_\_  
\_\_\_\_\_

Signature: \_\_\_\_\_ Date: \_\_\_\_\_



ALARM DEVICE MANUFACTURING COMPANY  
165 Eileen Way, Syosset, New York 11791

# EMERGENCY PHONE NUMBERS

Alarm Monitoring Station \_\_\_\_\_

Fire Department \_\_\_\_\_

Police \_\_\_\_\_

Gas/Electric Company \_\_\_\_\_

Neighbor \_\_\_\_\_

Doctor \_\_\_\_\_

Hospital \_\_\_\_\_

Ambulance \_\_\_\_\_

Emergency \_\_\_\_\_

## SERVICING INFORMATION

Your local Ademco dealer is the man best qualified to service your alarm system. Arranging some kind of regular service program with him is advisable. Your local Ademco dealer is:

\_\_\_\_\_  
\_\_\_\_\_  
\_\_\_\_\_  
\_\_\_\_\_

**WARNING**  
**THE LIMITATIONS OF THIS ALARM SYSTEM**

While this system is an advanced design security system, it does not offer guaranteed protection against burglary or fire. Any alarm system, whether commercial or residential, is subject to compromise or failure to warn for a variety of reasons, such as:

- Intruders may gain access through unprotected openings or have the technical sophistication to bypass an alarm sensor or disconnect an alarm warning device.
- Intrusion detectors (e.g., passive infrared detectors), smoke detectors, and many other sensing devices will not work without power. Battery operated devices will not work without batteries, with dead batteries, or if the batteries are not put in properly. Devices powered solely by AC will not work if their AC power supply is cut off for any reason, however briefly.
- Alarm warning devices such as sirens, bells or horns may not alert people or wake up sleepers if they are located on the other side of closed or partly open doors. If warning devices are located on a different level of the residence from the bedrooms, then they are less likely to waken or alert people inside the bedrooms. Even persons who are awake may not hear the warning if the alarm is muffled by noise from a stereo, radio, air conditioner or other appliances, or by passing traffic. Finally, alarm warning devices, however loud, may not warn hearing-impaired people.
- Telephone lines needed to transmit alarm signals from a premises to a central monitoring station may be out of service or temporarily out of service. Telephone lines are also subject to compromise by sophisticated intruders.
- While smoke detectors have played a key role in reducing residential fire deaths in the United States, they may not activate or provide early warning for a variety of reasons in as many as 35% of all fires, according to data published by the Federal Emergency Management Agency. Some of the reasons smoke detectors used in conjunction with this System may not work are as follows. Smoke detectors may not sense fires that start where smoke cannot reach the detectors, such as in chimneys, in walls, or roofs, or on the other side of closed doors. Smoke detectors also may not sense a fire on another level of a residence or building. A second floor detector, for example, may not sense a first floor or basement fire. Finally, smoke detectors have sensing limitations. No smoke detector can sense every kind of fire every time. In general, detectors may not always warn about fires caused by carelessness and safety hazards like smoking in bed, violent explosions, escaping gas, improper storage of flammable materials, overloaded electrical circuits, children playing with matches, or arson.
- This equipment, like other electrical devices, is subject to component failure. Even though this equipment is designed to last as long as 10 years, the electronic components could fail at any time.

The most common cause of an alarm system not functioning when an intrusion or fire occurs is inadequate maintenance. This alarm system should be tested weekly to make sure all sensors are working properly.

Installing an alarm system may make one eligible for lower insurance rates, but an alarm system is not a substitute for insurance. Homeowners, property owners and renters should continue to insure their lives and property.



A DIVISION OF PITTMAY CORPORATION